

# JBC

[www.jbctools.com](http://www.jbctools.com)

English



## Four-Tool Control Unit

Ref. DME-A

# Packing List

The following items should be included:

**Four-Tool Control Unit** ..... 1 unit  
Ref. DME-1A (120V)  
DME-2A (230V)  
DME-9A (100V)

**Power Cord** ..... 1 unit  
Ref. 0010569 (230V)  
0013671 (100/120V)

**Manual** ..... 1 unit  
Ref. 0012837



# Features

3.5" Color TFT  
Touch screen

Tilt the display for  
easy reading

USB-A connector

Speaker



## Connections

Work simultaneously with **up to 4** tools and 1 module + 1 pedal for each tool (Peripherals).

### Control Unit

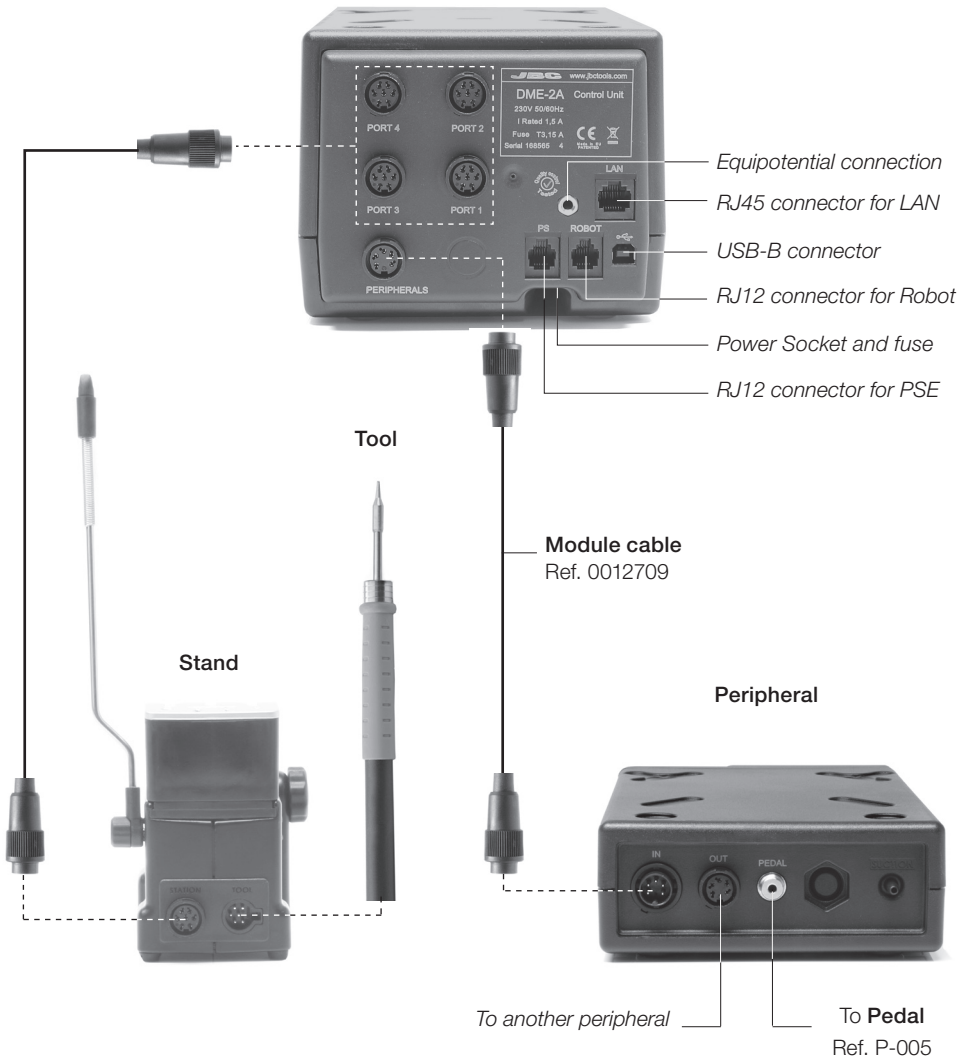

# Stands & Tools

For a basic working system you need: 1 Stand, 1 Tool and 1 Cartridge or tip.

## Stands

Ref. AD-SD



Ref. DN-SE



Ref. AP-SD



## Tools

**Precision Handle**  
Ref. T210-A

**General Purpose Handle**  
Ref. T245-A

**HD Handle**  
Ref. T470-A

**Nitrogen Handles\***  
Ref. T210-NA  
T245-NA  
T470-NA

**Solder Feed Iron**  
Ref. AP250-A



\* The MNE Nitrogen Flow Regulator is required to work.



## Cartridges

C210



C245



C210



C245



C250



Ref. PA-SD



Ref. HT-SD



Ref. DS-SD



Ref. DR-SD



**Micro Tweezers**

Ref. PA120-A

**Thermal Tweezers**

Ref. HT420-A

**Micro Desoldering Iron**

Ref. DS360-A

**Desoldering Iron**

Ref. DR560-A



C120



C420



C360



C560



# Peripherals



By pressing **Peripherals** in the main MENU, you can join tool ports with peripherals which means each tool can work with 1 module and 1 pedal at the same time.



**Four-Tool Control Unit**  
Ref. DME-A

**Electric Desoldering Module**  
Ref. MSE-A



**Pneumatic Desoldering Module**  
Ref. MVE-A



**Nitrogen Flow Regulator**  
Ref. MNE-A



**Fume Extractor Switch**  
Ref. FSE-A



**Pedal**  
Ref. P-005



Function: **Enable/disable** the module or make any tool enter **Sleep** or **Hibernation** modes. This pedal will work with any module or tool regardless of the module to which it is connected. If you do not have a module, you can link up the P-305 Pedal Kit to the tool port.

## Compatibility

Select the equipment that best suit your soldering or desoldering needs.

Basic working system				Peripherals**			
Control Unit	Stand	Tool	Cartridge Range	MSE-A / MVE-A	MNE-A	FSE-A	P-005
DME-A	AD-SD	T210-A	C210			●	●
		T245-A	C245			●	●
		T470-A	C245			●	●
	DN-SE	T210-NA*	C210		●		●
		T245-NA*	C245				
		T470-NA*					
	AP-SD	AP250-A	C130			●	●
	PA-SD	PA120-A	C120			●	●
	HT-SD	HT420-A	C420			●	●
	DS-SD	DS360-A	C360	●			●
DR-SD	DR560-A	C560	●			●	

\* The **MNE** Nitrogen Flow Regulator is required.

\*\*If you need to connect the **MS**, **MV**, **MN** or **FS** modules, an adapter is required (Ref. IM2496).

## P-305 Pedal Kit

By using the Connection Box, the P-005 Pedal will work with **only the tool port** to which it is connected.

Function:

Makes the tool enter/skip from **Sleep** mode.

Connection Box + Pedal  
Ref. 0012527 Ref. P-005



# Operation

## The JBC Exclusive Heating System

Our revolutionary technology is able to recover tip temperature extremely quickly. It means the user can work at a lower temperature and improve the quality of soldering. The tip temperature is further reduced thanks to the Sleep and Hibernation modes which increase the tip life by 5.

### 1. Work



When the tool is lifted from the stand the tip will heat up to the selected temperature.

### 2. Sleep

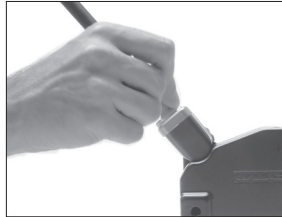

When the tool is in the stand, the temperature falls to the preset Sleep temperature.

### 3. Hibernation



After longer periods of inactivity, the power is cut off and the tool cools down to room temperature.

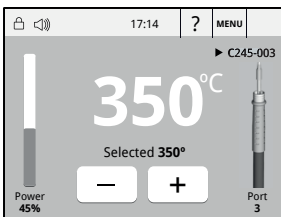

Tools Menu:

- Adjust temperature and cartridge
- Set temperature levels



Tools Menu:

- Set Sleep temperature
- Set Sleep delay (from 0 to 9 min or no Sleep)

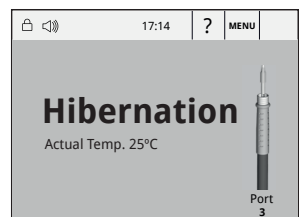

Tools Menu:

- Set Hibernation delay (from 0 to 60 min or no hibernation)



## Work Screen

The DME-A offers an intuitive user interface which provides quick access to the station parameters.

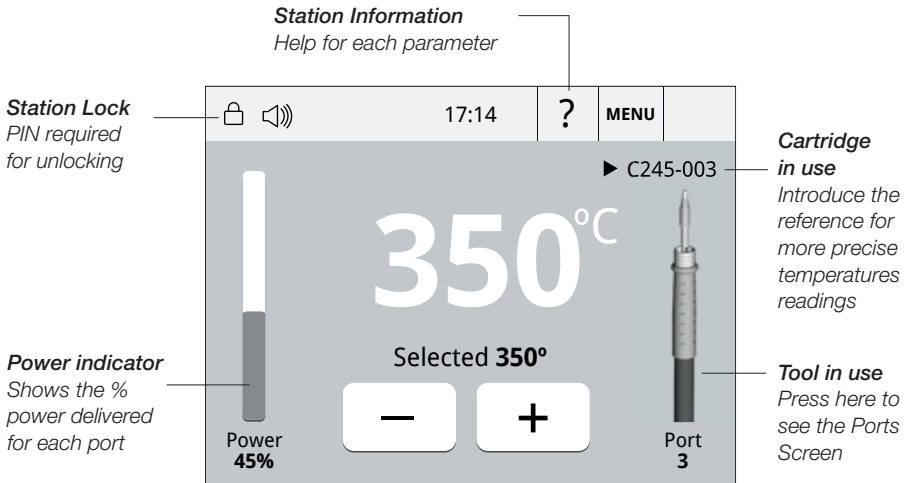

## Simultaneous control of ports

See the information of all ports in real time when pressing the tool image from the Work screen.

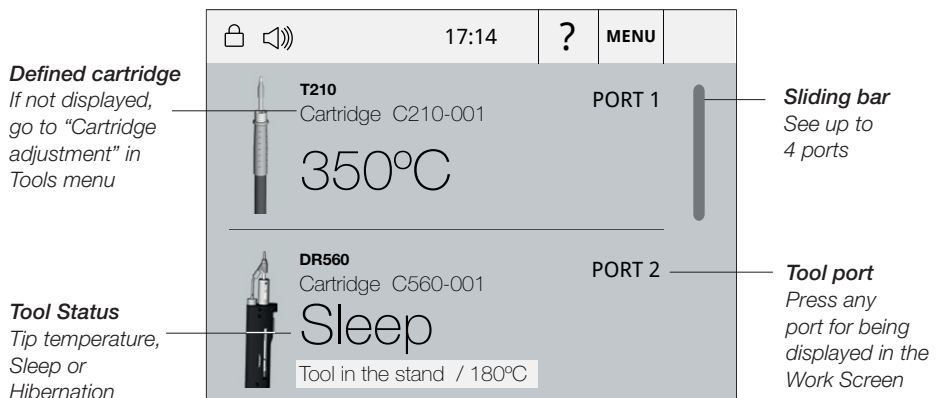

# Menu Screen

Select any option and press the station information button to display each parameter description.

*Adjust tool settings for each port*

*Join station ports with modules and pedals*

**Personalize the station:**  
 Station name, PIN activation, Screen settings, Robot activation, Partial resets...

**Registers total and partial hours** for each port: work, sleep, hibernation...

**Multi-language**  
 Up to 8 languages to choose from.

**Utilities**

Useful additional applications that complement and support your work.

View your video\* via USB, or import it from your PC

Unit Converter °C - °F - K

Connect a microscope\*\* via USB and see your work on the screen

Monitor and save your soldering process to **optimize** production

\* Format file video: AVI and MP4 / Resolution: 320x240 / Aspect ratio: 16:9 / Frame rate: 18 FPS

\*\*Recommended model: Dino-Lite AM2011 and equivalent.

## Cartridge Adjustment

Insert the cartridge model and the station will recognize its characteristics (size and shape) to provide more accurate temperature readings.

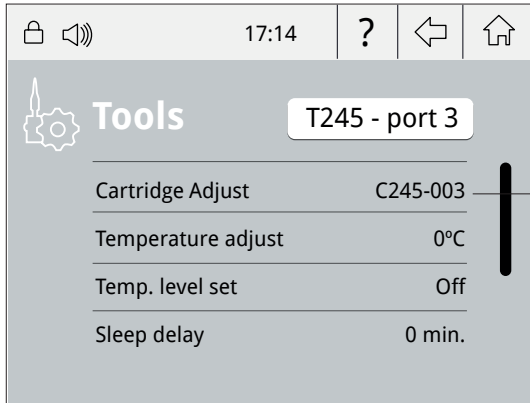



*After connecting the tool, introduce the last 3 reference numbers of the cartridge.*

## System notifications

The following icons may be displayed on the status bar on the screen.

 USB flash drive is connected to the USB-A.

 Warning.  
Press here for description.

 Station is controlled by a PC.

 Error.  
Press here for failure description, the type of error and how to proceed.

 Station is controlled by a robot.

 The station is being updated by a USB flash drive.

 Indicates there is a peripheral to be installed.

# Process analysis

Optimize your production after analysing the information provided by the graphics.



Graphics

By pressing **Graphics** in the Utilities MENU, temperature and power figures in real time are displayed for each port. This helps you decide how to adjust your process or which tip to use to obtain the best quality soldering.

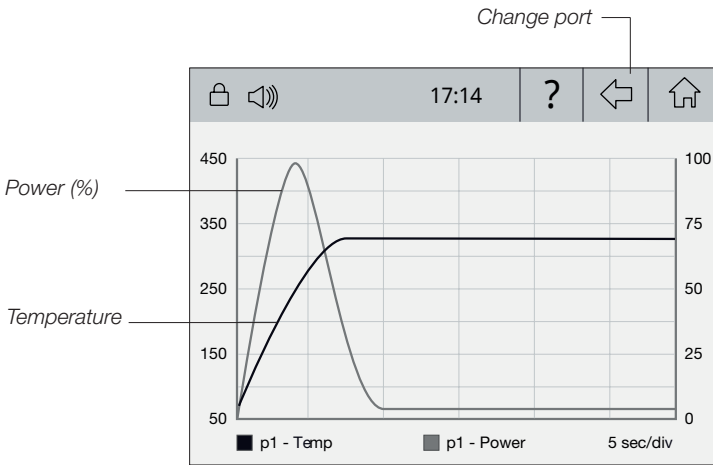

## Export graphics

Insert a USB flash drive into the USB-A connector to save your soldering process in csv format.



## Soldering Network

Remotely manage and monitor as many stations as your PC can handle.

1. Download the **JBC Manager software** and the user manual from [www.jbctools.com/manager.html](http://www.jbctools.com/manager.html)
2. Connect the stations via USB-B or LAN (RJ45) and the PC will automatically detect them.
3. The icon  will appear on the screen.

### Functions:

- Set all the station parameters from your PC.
- Organize groups of stations and set all their parameters at the same time.
- Store specific configurations for later uses.
- Analyze the soldering graphics of the stations on your PC and export them.

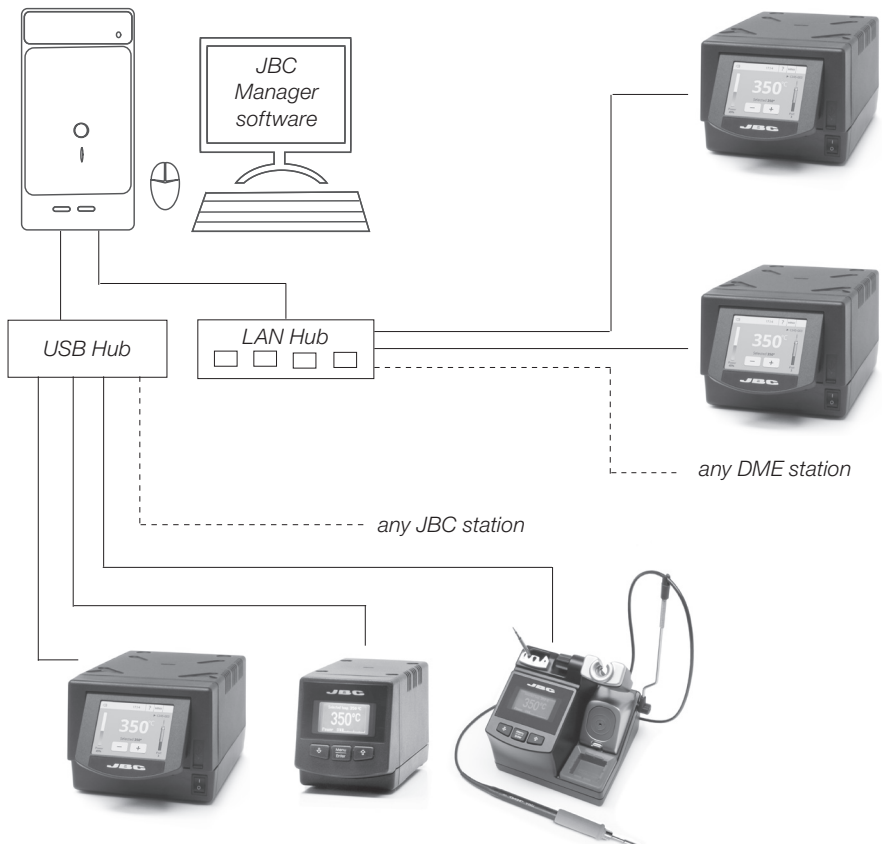

# Increase x4 your DME's possibilities

Centralize control of 3 PSE Power Supply Units in a single DME and work with as many as 16 tools simultaneously.

1. Connect the DME to the **PSE Power Supply Units** via the PS connector (RJ12).
2. Connect the other PSE's as follows:

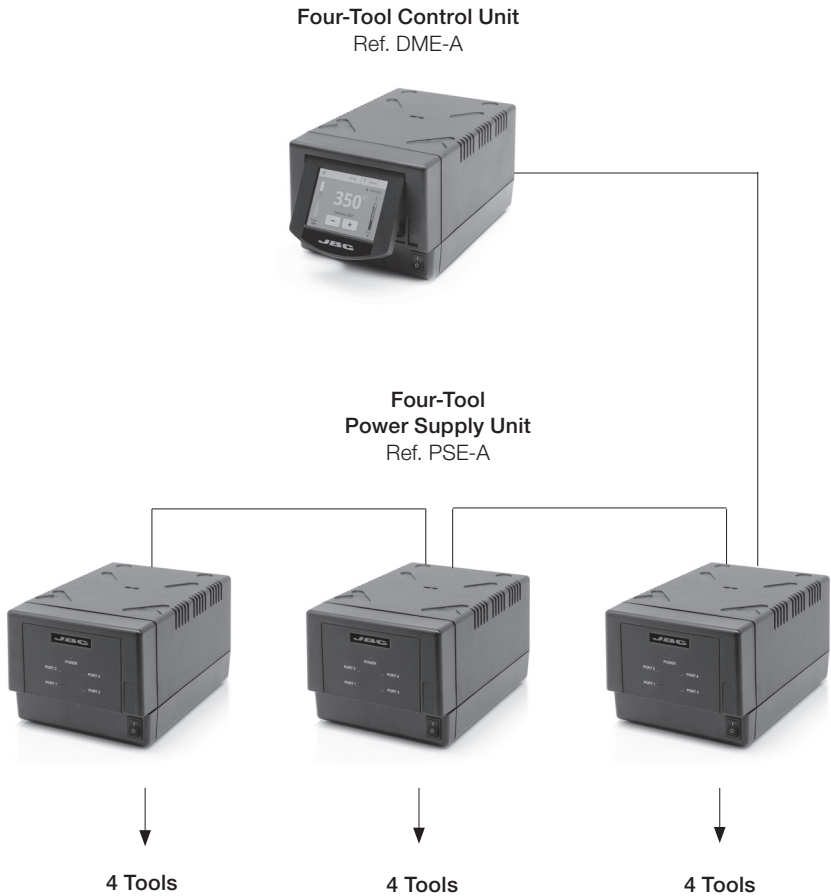

## Working with Robots

Manage and monitor the station using a Robotic system.

1. Connect the tool to the station port by means of the CHB-A Converter.
2. Connect your Robot system to the station's Robot connector (RJ12).  
DB9-RJ12 Adapter available on request (Ref: 0013772).
3. Enable the Robot option in the station settings and the icon will appear: 
4. Set your Robot's commands according to the Robot Communication Protocol, available on the website [www.jbctools.com/jbcsoftware-menu-115.html](http://www.jbctools.com/jbcsoftware-menu-115.html).

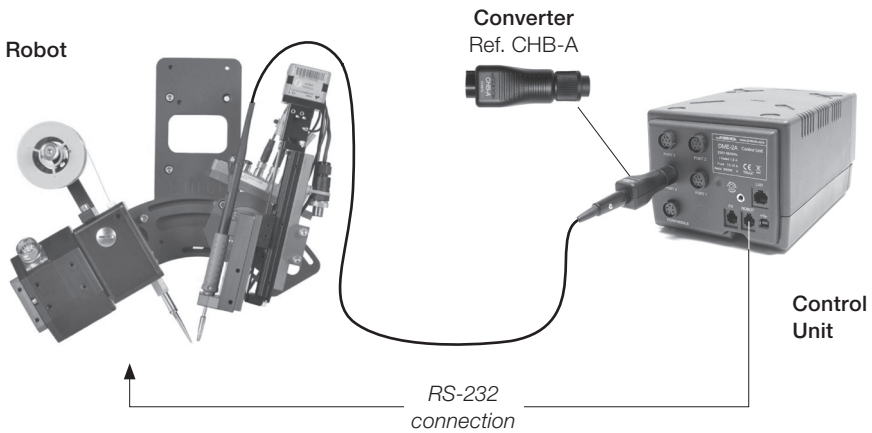

## Update the station software

1. Download the update file when available at [www.jbctools.com/software.html](http://www.jbctools.com/software.html) and save it on a USB flash drive. Preferably one with no other files.
2. Insert the USB flash drive.  
The icon  is displayed while updating.

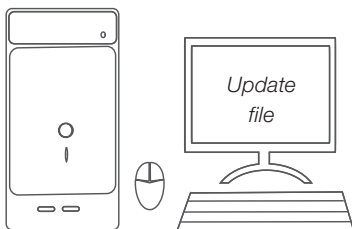

## Maintenance

Before carrying out maintenance or storage, always allow the equipment to cool.

- Clean the station screen with a glass cleaner or a damp cloth.
- Use a damp cloth to clean the casing and the tool. Alcohol can only be used to clean the metal parts.
- Periodically check that the metal parts of the tool and stand are clean so that the station can detect the tool status.
- Maintain tip surface clean and tinned prior to storage in order to avoid tip oxidation. Rusty and dirty surfaces reduce heat transfer to the solder joint.
- Periodically check all cables and tubes.
- Replace a blown fuse as follows:

*Clean periodically*

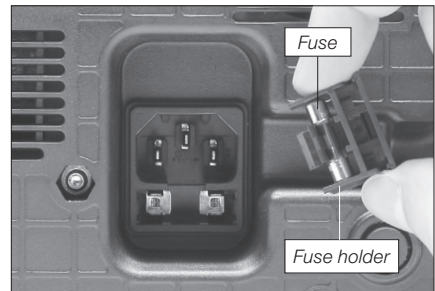
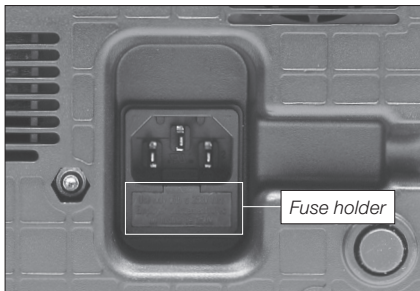

**1.** Pull off the fuse holder and remove the fuse. If necessary use a tool to lever it off.

**2.** Press the new fuse into the fuse holder and replace it in the station.

- Replace any defective or damaged pieces. Use original JBC spare parts only.
- Repairs should only be performed by a JBC authorized technical service.



## Safety



**It is imperative to follow safety guidelines to prevent electric shock, injury, fire or explosion.**

- Do not use the units for any purpose other than soldering or rework. Incorrect use may cause fire.
- The power cord must be plugged into approved bases. Be sure that it is properly grounded before use. When unplugging it, hold the plug, not the wire.
- Do not work on electrically live parts.
- The tool should be placed in the stand when not in use in order to activate the sleep mode. The soldering tip, the metal part of the tool and the stand may still be hot even when the station is turned off. Handle with care, including when adjusting the stand position.
- Do not leave the appliance unattended when it is on.
- Do not cover the ventilation grills. Heat can cause inflammable products to ignite.
- Avoid the contact of flux with skin or eyes to prevent irritation.
- Be careful with the fumes produced when soldering.
- Keep your workplace clean and tidy. Wear appropriate protective glasses and gloves when working to avoid personal harm.
- Utmost care must be taken with liquid tin waste which can cause burns.
- This appliance can be used by children over the age of eight and also persons with reduced physical, sensory or mental capabilities or lack of experience provided that they have been given adequate supervision or instruction concerning use of the appliance and understand the hazards involved. Children must not play with the appliance.
- Maintenance must not be carried out by children unless supervised.

## Specifications

**DME-1A** 120V 50/60Hz. Input fuse: 6A. Output: 23.5V

**DME-2A** 230V 50/60Hz. Input fuse: 3.15A. Output: 23.5V

**DME-9A** 100V 50/60Hz. Input fuse: 8A. Output: 23.5V

- Weight: 4.573 Kg (10.08 lb)
- Dimensions: 148 x 120 x 232 mm
- Output Peak Power: 160W per tool
- Temperature Range: 90-450°C (190-840°F)
- Idle Temp. Stability (still air):  $\pm 1.5$  °C ( $\pm 3$  °F)
- Ambient Operating Temperature: 10-40 °C (50-104 °F)
- Tip to ground resistance: <2 ohms
- Tip to ground voltage: <2mV RMS
- USB-A / USB-B / Peripherals connectors
- RJ12 connectors: 1 for Robot and 1 for PSE Power Supply Control Unit.
- RJ45 connector for LAN (Ethernet).

Complies with CE standards

ESD protected housing "skin effect"

## Exploded View

SPARE PARTS	
<b>DME-1A / DME-2A / DME-9A:</b>	
-CIRCUIT	0016342
-ENCLOSURE	
· TOP	0011035
· BOTTOM	0014567
· FRONT+DISPLAY	0011014
· BACK	0011861

DME-1A 120V FUSE T-6A  
 DME-2A 230V FUSE T-3,15A  
 DME-9A 100V FUSE T-8A

0012724  
 BATTERY  
 CR2032

0016342

**DME-1A 120V**  
**DME-2A 230V**  
**DME-9A 100V**  
**FOUR-TOOL CONTROL UNIT**  
 FROM SERIE 172552

DME-1A / DME-2A / DME-9A

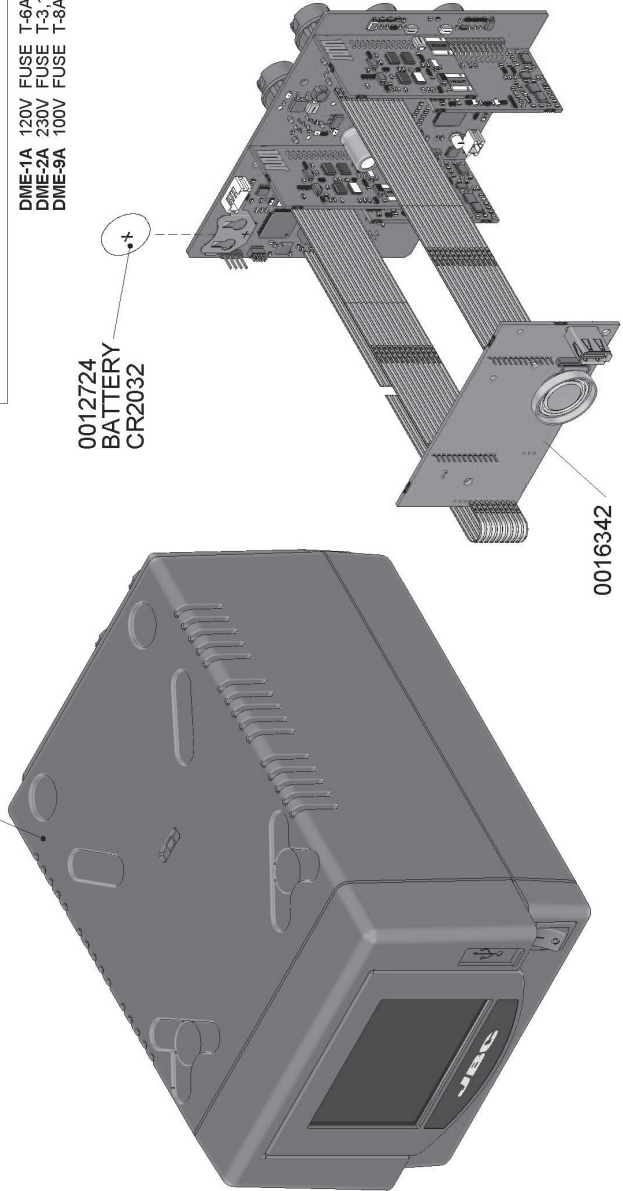

# JBC

---

## Warranty

JBC's 2 year warranty covers this equipment against all manufacturing defects, including the replacement of defective parts and labour.

Warranty does not cover product wear due to use or mis-use.

In order for the warranty to be valid, equipment must be returned, postage paid, to the dealer where it was purchased.

---



This product should not be thrown in the garbage.

In accordance with the European directive 2012/19/EU, electronic equipment at the end of their life must be collected and returned to an authorized recycling facility.